



ORIENT

Photo coupler

Product Data Sheet

Name: OR-M501

Customer:

Date:

一级代理商：

深圳市弗瑞鑫电子有限公司

地址：深圳市宝安区西乡大道302号金源商务大厦B座三楼

TEL: 0755-29563634

FAX: 0755-27447020

www.frxelec.com

1. Features

- (1) Compliance Halogens Free (Br < 900ppm, Cl < 900ppm, Br+Cl < 1500ppm)
- (2) High speed - 1MBd model.
- (3) Adapted to the dual-in-line, lead spacing width, surface installation.
- (4) Store output.
- (5) Safety approval
 - UL approved(No.E323844)
 - VDE approved(No.40029733)
 - CQC approved (No.CQC19001231256)
- (6) In compliance with RoHS, REACH standards
- (7) MSL Class I



2. Instructions

OR-M501 consists of highly efficient AlGaAs light-emitting diodes and high-speed optical detectors. The design provides good ac and dc isolation at the input and output ends of the photoelectric coupler. Connections related to photodiode biasing can improve the speed of conventional phototransistor couplers by reducing the capacitance of the matrix collector. Internal shielding ensures high transient immunity in general mode. Ensure the common-mode transient immunity to 1 kV/μs.

3. Application Range

- line receiver isolation
- switching power supply
- motor control system

4. Functional Diagram

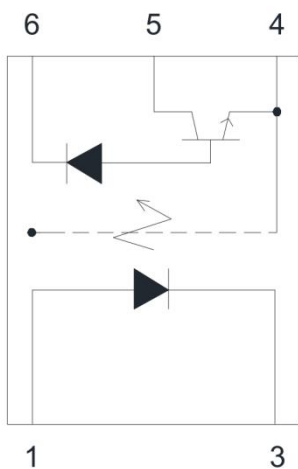

- 1. Anode
- 3. Cathode
- 4. GND
- 5. Vo (Output)
- 6. Vcc

Truth table	
Input (LED)	Output
ON	L
OFF	H

5. Absolute Maximum Ratings (Ta=25°C) *1

Parameter		Symbol	Rated Value	Unit
Input	Average Forward Input Current	I _F	25	mA
	Reverse Input Voltage	V _R	5	V
	Power Dissipation	P _I	45	mW
Output	Output Collector Current	I _O	8	mA
	Output Collector Voltage	V _O	20	V
	Output Collector Power	P _O	100	mW
Supply Voltage		V _{CC}	30	V
Insulation Voltage		V _{iso}	3750	V _{rms}
Working Temperature		T _{opr}	-55~+ 100	°C
Storage Temperature		T _{stg}	-55~+ 125	
*2 Soldering Temperature		T _{sol}	260	

*1. Room temperature = 25 °C. Exceeding the maximum absolute rating can permanently damage the device. Working long hours at the maximum absolute rating can affect reliability.

*2. soldering time is 10 seconds.

6. Electrical optical characteristics at TA=25°C

Parameter	Symbol	Min	Typ	Max	Unit	Condition
Forward voltage	V _F	1.2	1.4	1.8	V	I _F = 16mA
Reverse voltage	BV _R	5	—	—	V	I _R = 10μA
Current transfer ratio	CTR	20	36	50	%	I _F = 16mA, V _O =0.4V, V _{CC} =4.5V
Low Level Output Voltage	V _{OL}	—	0.2	0.4	V	V _{CC} =4.5V, I _F =16mA,
High Level Output Current	I _{OH}	—	0.005	1	uA	V _{CC} =15V, V _O =15V,I _F =0mA
Low Level Supply Current	I _{CCL}	—	80	200	uA	I _F =16mA,V _O =open, (V _{CC} =15V)
High Level Supply Current	I _{CCH}	—	0.002	1	uA	I _F =0mA,V _O =open, (V _{CC} =15V)

7. Switching Characteristics at TA=25°C

Parameter	Symbol	Condition	Min	Typ	Max	Unit
Propagation delay time to output Low level	t_{PHL}	$R_L=1.9k\Omega$ $I_F=16mA$	—	0.19	0.8	μs
Propagation delay time to output High level	t_{PLH}	$R_L=1.9k\Omega$ $I_F=16mA$	—	0.15	0.8	μs
Logic High Common Mode Transient Immunity	$ CM_H $	$C_L=15pF$ $V_{CM}=1500V_{p-p}$, $R_L=1.9k\Omega$, $I_F=0mA$	15	25	—	$kV/\mu s$
Logic Low Common Mode Transient Immunity	$ CM_L $	$V_{CM}=1500V_{p-p}, C_L=15pF$ $R_L=1.9k\Omega$, $I_F=16mA$	15	25	—	$kV/\mu s$

Recommended temperature range ($T_A = 0\text{ }^\circ\text{C} \text{ -- } 70\text{ }^\circ\text{C}$), unless otherwise specified power supply for 5 v.
Typical values of $T_A = 25\text{ }^\circ\text{C}$.

8. Isolation characteristics at TA=25°C

Parameter	Symbol	Condition	Min	Typ	Max	Unit
Input-Output Insulation Leakage Current	I_{I-O}	45% RH, $t=5s$, $V_{I-O} = 3kV\text{ DC}, T_A = 25^\circ\text{C}$	—	—	1	μA
Withstand Insulation Test Voltage	V_{ISO}	$RH \leq 50\%$, $t = 1\text{ min}, T_A = 25^\circ\text{C}$	3750	—	—	V_{RMS}
Input-Output Resistance	R_{I-O}	$V_{I-O} = 5000V\text{ DC}$	—	10^{12}	—	Ω



9. Order Information

Part Number

OR-M501-X-Y-Z

Note

X = Tape and reel option (TP or TP1).

Y = 'V' code for VDE safety (This options is not necessary).

Z = 'G' code for Halogen free.

* VDE Code can be selected.

Option	Description	Packing quantity
TP	Surface mount lead form (low profile) + TP tape & reel option	3000 units per reel
TP1	Surface mount lead form (low profile) + TP1 tape & reel option	3000 units per reel

10. Naming Rule

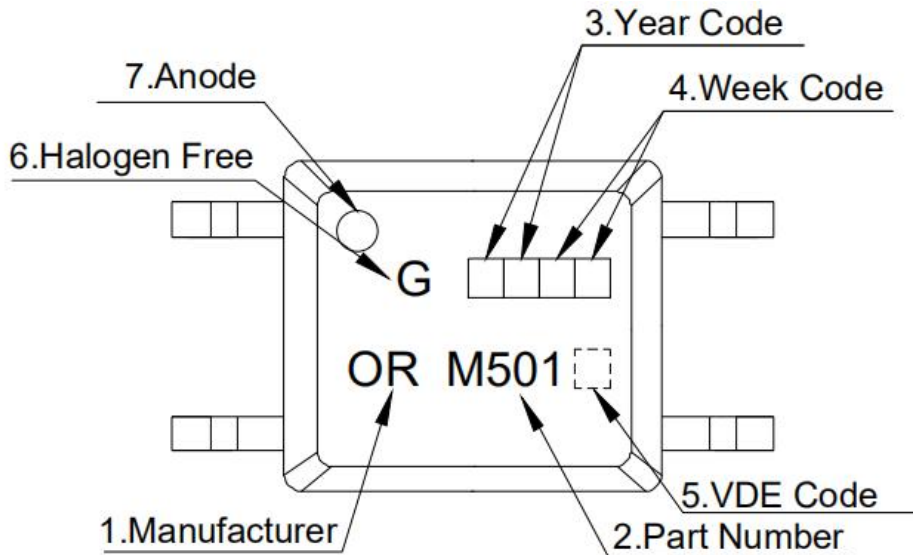

1. Manufacturer : ORIENT.
2. Part Number : M501.
3. Year Code : '21' means '2021' and so on.
4. Week Code : 01 means the first week, 02 means the second week and so on.
5. VDE Code . (Optional)
6. HF Code 'G': Halogen Free.
7. Anode.

* VDE Code can be selected.

11. Outer Dimension

(1) OR-M501

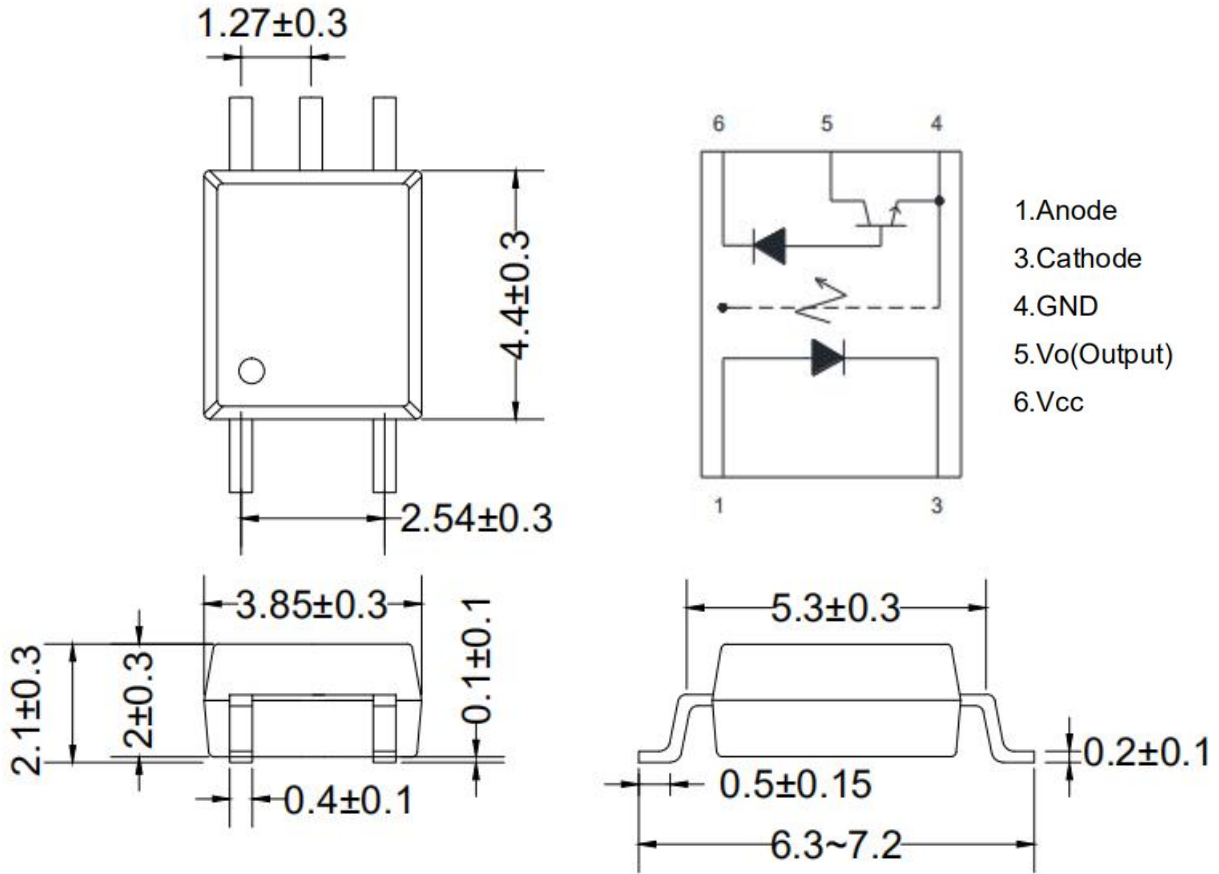

12. Recommended Foot Print Patterns (Mount Pad)

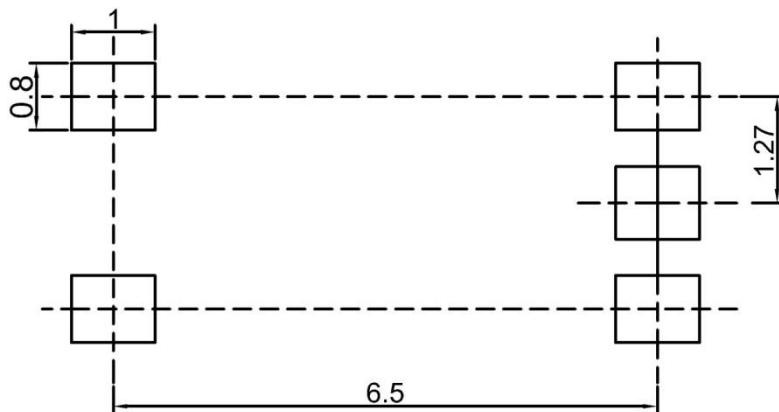

unit : mm

13. Taping Dimensions

(1) OR-M501-TP

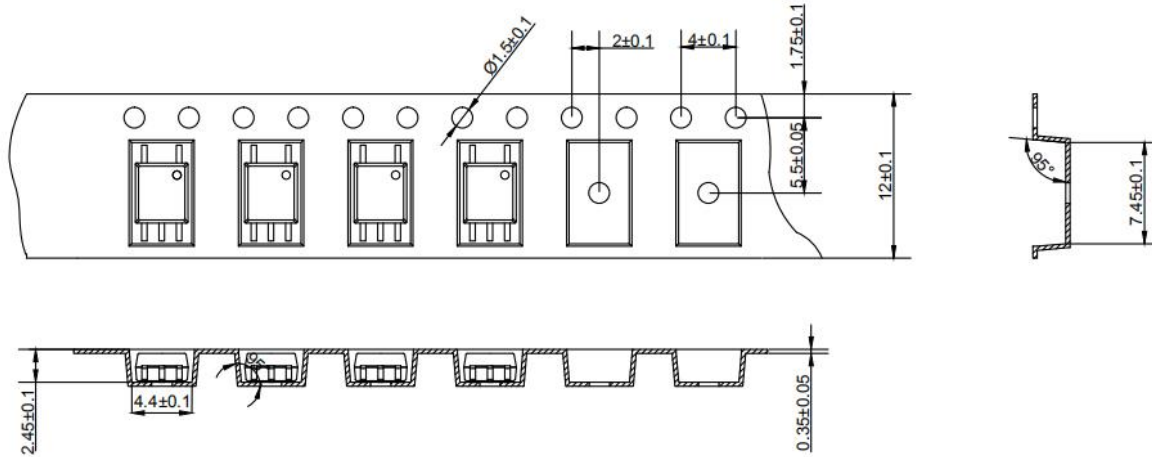

(2) OR-M501-TP1

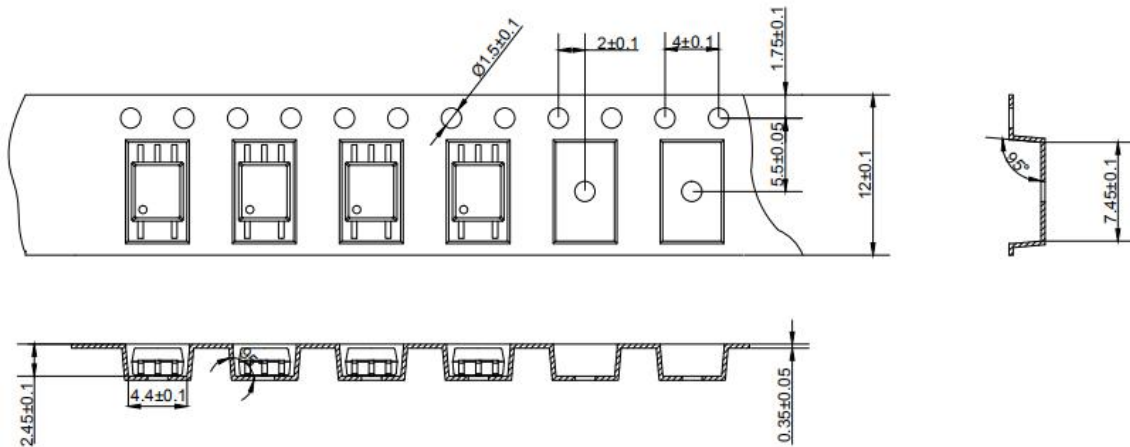

Description	Symbol	Dimension in mm(inch)
Tape wide	W	12 ± 0.3 (0.472)
Pitch of sprocket holes	P0	4 ± 0.1 (0.157)
Distance of compartment	F	5.5 ± 0.1 (0.217)
	P2	2 ± 0.1 (0.079)
Distance of compartment to compartment	P1	8 ± 0.1 (0.315)

Encapsulation type	TP/TP1
amount (pcs)	3000

14. Package Dimension



(1) package dimension

Packing Information	
Packing type	Reel type
Tape Width	12mm
Qty per Reel	3,000pcs
Small box (inner) Dimension	345*345*45mm
Large box (Outer) Dimension	480x360x360mm
Max qty per small box	6,000pcs
Max qty per large box	60,000pcs

(2)Packing Label Sample



Material Code : 120PCXXXXXX
|||||
P/N : OR-XXXXXX
|||||
Lot No. : XXXXXX-XXXXX-TX-X
|||||
D/C : XXXX
|||||
Qty : XXXX PCS
|||||

内箱码

外箱码

“XXXXXXXXXXXXXXXXXX” (一体机序列码)

Made in China

Note:

1. Material Code :Product ID.
2. P/N :Contents with "Order Information" in the specification.
3. Lot No. :Product data.
4. D/C :Product weeks.
5. Quantity :Packaging quantity.

15. Reliability Testing

NO.	ITEMS	Reliability Testing				
		QTY. (Pcs)	Condition	Process	Device	Standard
1	RSH 耐焊接热	22	260±5°C	5s/3 次	锡炉	JESD22-A106
2	HTSL 高温存储	77	125°C	168 hrs	高温烤箱 测试仪	JESD22-A103
				500 hrs		
				1000 hrs		
3	LTSL 低温存储	77	-40°C	168 hrs	低温箱 测试仪	JESD22-A119
				500 hrs		
				1000 hrs		
4	TC 温度循环	77	H:125°C 15min ↓5min L:-55°C 15min	300 cycle	冷热冲 击机	JESD22-A104
5	TS 温度冲击	77	H:100°C 5min ↓15s L:-40°C 5min	300 cycle	冷热冲 击机	JESD22-A106
6	HTOL 高温操作	77	100°C IF=10mA Vcc=5V	168 hrs	高温烤 箱 测试仪、 老化电 路板	JESD22-A108
				500 hrs		
				1000 hrs		
7	ESD-HB M 人体模式	22	≥8KV 1Cycle	1 次	ESD 静 电测试 仪	JESD22-A114
8	SD 可焊性	22	Pb-free 245±5°C	5s/1 次	锡炉	JESD22-B102
9	HTHB 温湿寿命 试验	77	85°C,85%RH IF=10mA,Vcc=5V	168 hrs	恒温恒湿 机, 测试 仪	JESD22-A101
				500 hrs		
				1000 hrs		
10	Autoclave 压力锅	77	Ta=121 °C,100%RH,2atm	96hrs	压力锅	JESD22-A102

16. Temperature Profile Of Soldering

(1) IR Reflow soldering (JEDEC-STD-020C compliant)

Note: one solder backflow is recommended under the conditions described below in the temperature and time profile. Do not weld more than three times.

Profile item	Conditions
Preheat - Temperature Min (T Smin) - Temperature Max (T Smax) - Time (min to max) (ts)	150°C 200°C 90±30 sec
Soldering zone - Temperature (TL) - Time (t L)	217°C 60 sec
Peak Temperature	260°C
Peak Temperature time	20 sec
Ramp-up rate	3°C / sec max.
Ramp-down rate from peak temperature	3~6°C / sec
Reflow times	≤3

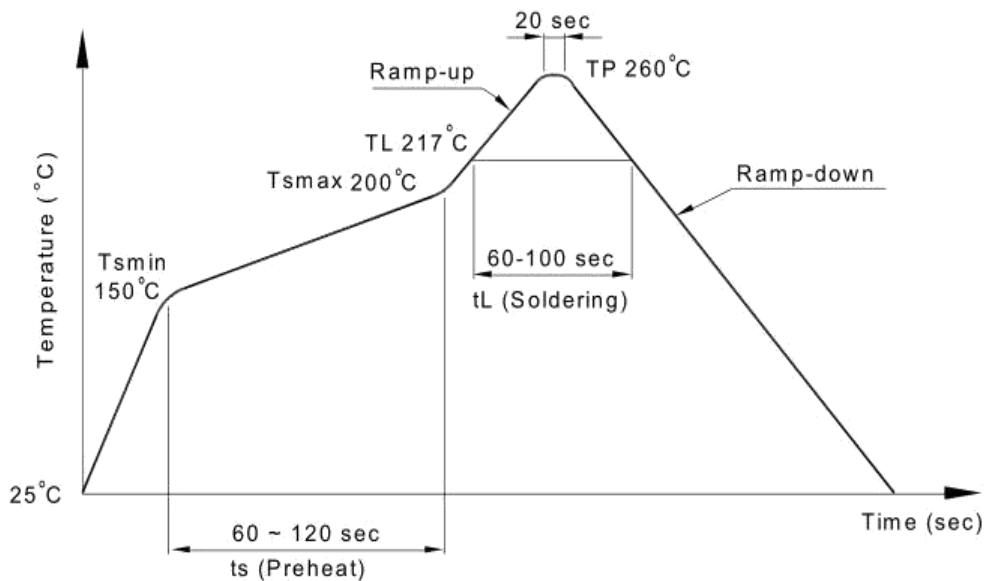

(2) Wave soldering (JEDEC22A111 compliant)

One-time welding is recommended under the temperature condition.

Temperature	260+0/-5°C
Time	10 sec
Preheat temperature	5 to 140°C
Preheat time	30 to 80 sec

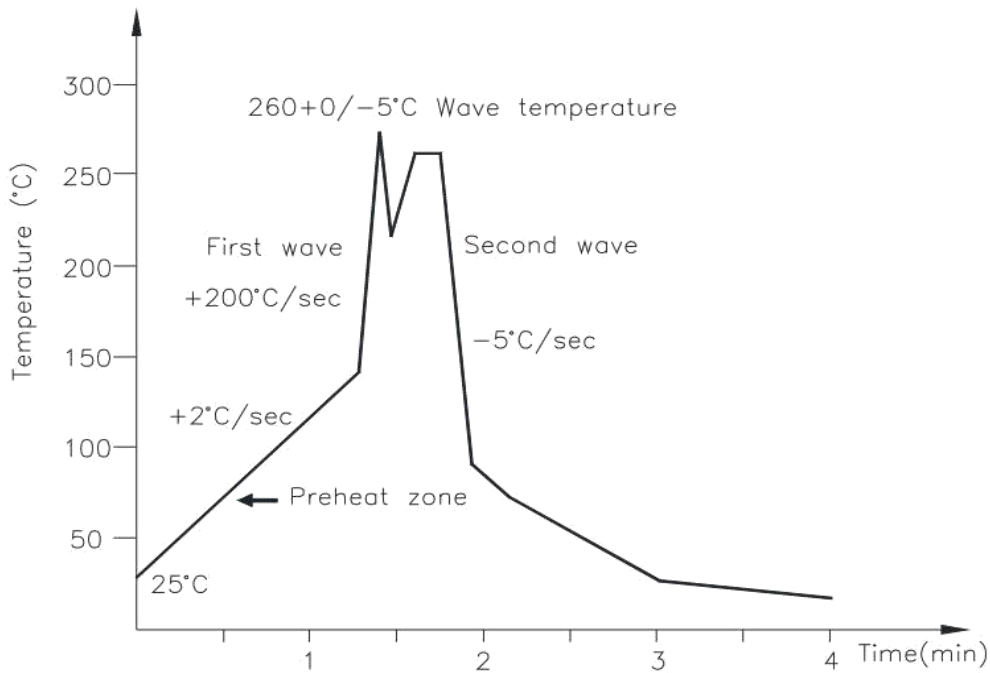

(3) Hand soldering by soldering iron

Single lead welding is allowed in each process and one-time welding is recommended.

Temperature	380+0/-5°C
Time	3 sec max

17. Switching Time Test Circuit

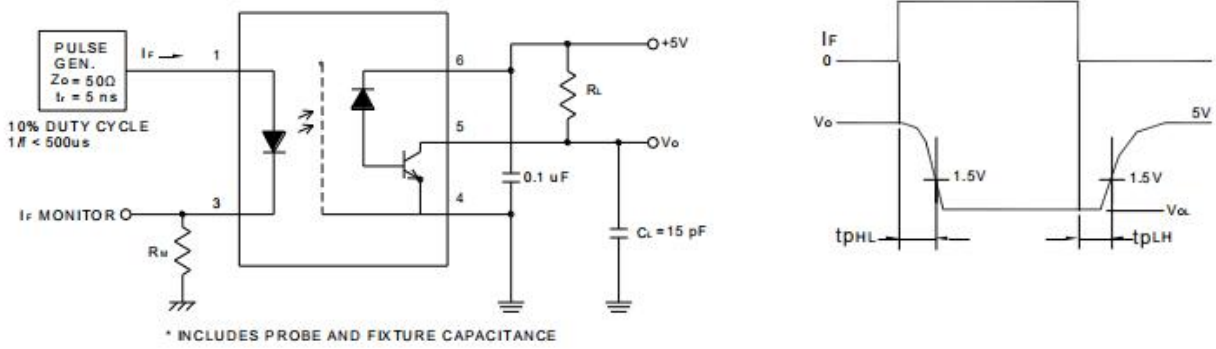

Figure 1: Test Circuit for t_{PHL} and t_{PLH}

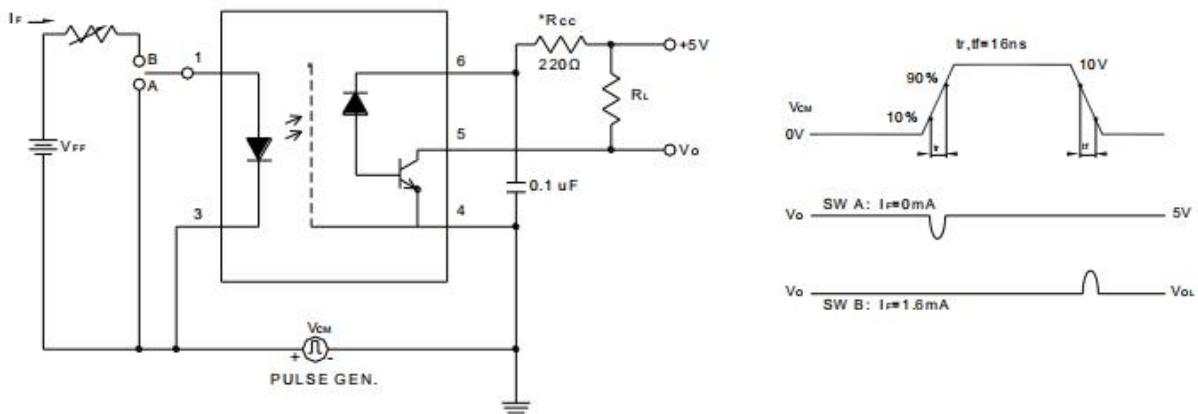

Figure 2: Single Channel Test Circuit for Common Mode Transient Immunity

Characteristics Curve

Figure 3: DC and pulsed transfer characteristics

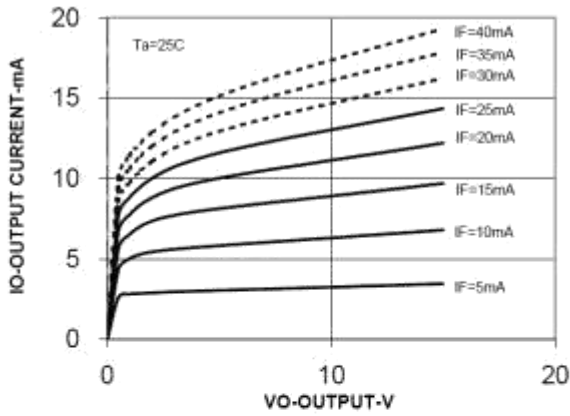

Figure 6: Current transfer ratio vs. input current

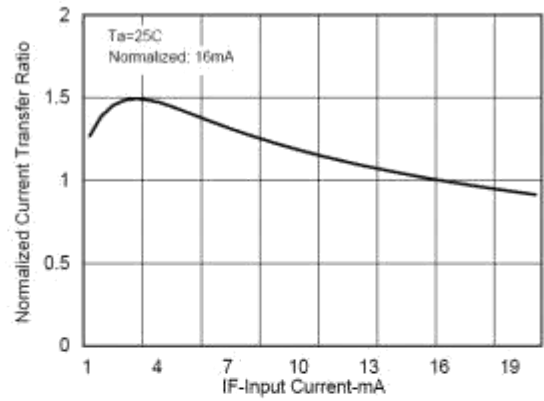

Figure 4: Input current vs. forward voltage

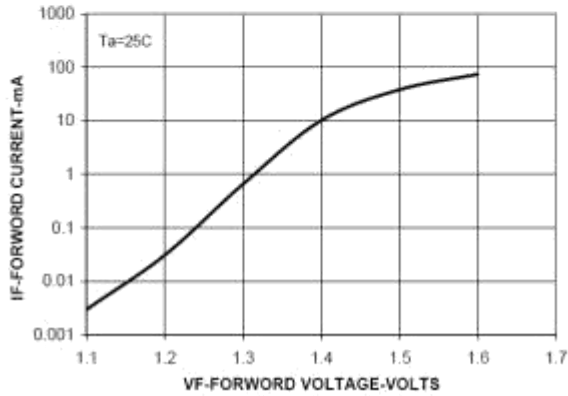

Figure 7: NORMALIZED CURRENT TRANSFER RATIO VS. AMBIENT TEMPERATURE

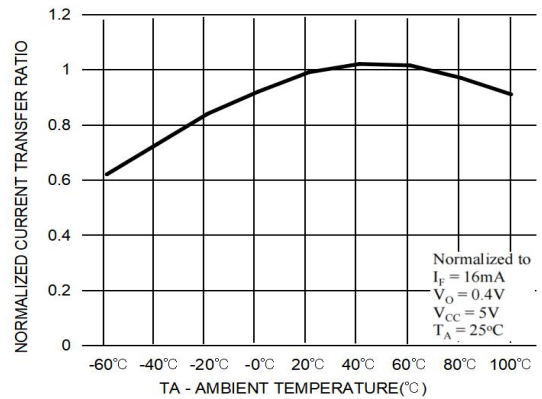

Figure 5: Logic high output current vs. temperature

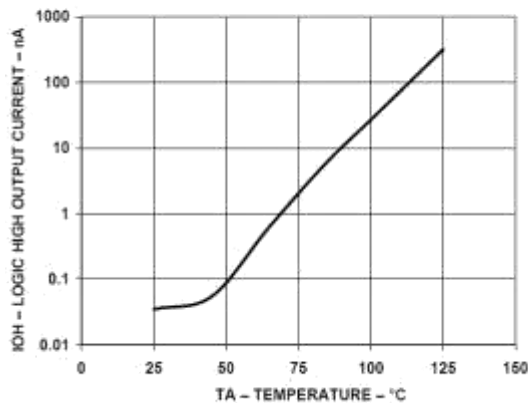

Figure 8: Small-signal current transfer ratio vs. quiescent current

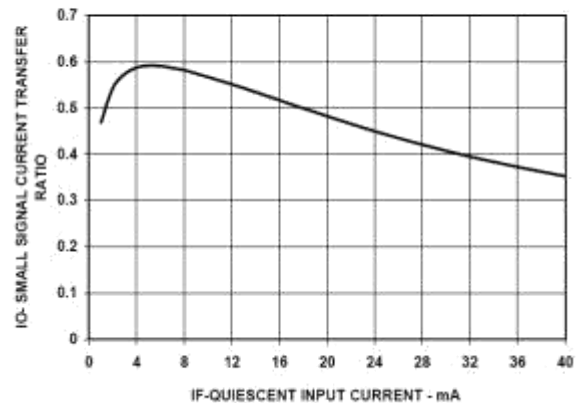

Figure 9: Propagation delay time vs. temperature

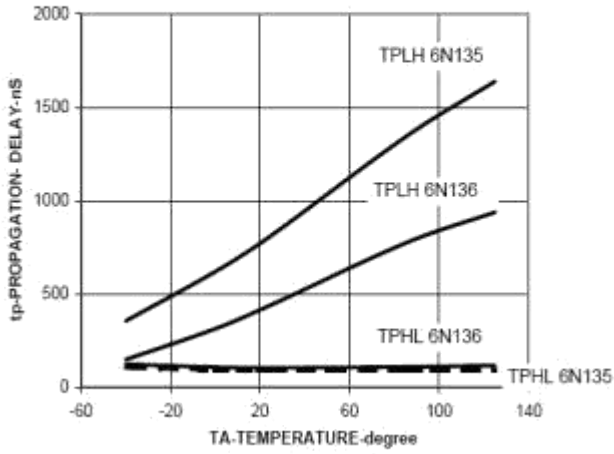

Figure 10: Propagation delay time vs. load resistance

